

CP-120 DEVICE FOR MWP-220 OR MWP-345

APPLICATION

CP-120 device is designed for magnetic oil level indicator MWP-220 or MWP-345 to show oil level in conservator with resin diaphragm. This device is used in conservator with diameter 1200 mm.

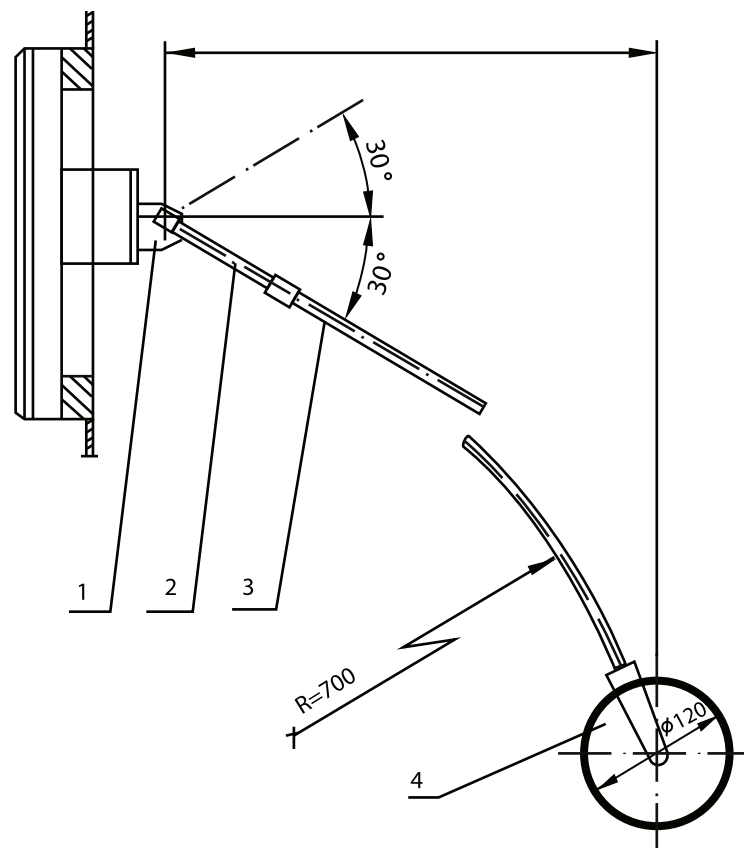

DESIGN AND OPERATION

Runner 4 moves on diaphragm of the conservator transferred through arm 2 to gear transmission 1 (with ratio 2:1). Gear transmission 1 is connected with oil level indicator MWP 220 or MWP345 which is fixed to the vertical wall of the conservator.